

Bond University  
Research Repository



## Robotic variable fabric formwork

Yang, Xuyou; Loh, Paul; Leggett, David

*Published in:*  
Journal of Computational Design and Engineering

*DOI:*  
[10.1016/j.jcde.2018.10.001](https://doi.org/10.1016/j.jcde.2018.10.001)

*Licence:*  
CC BY-NC-ND

[Link to output in Bond University research repository.](#)

*Recommended citation(APA):*  
Yang, X., Loh, P., & Leggett, D. (2019). Robotic variable fabric formwork. *Journal of Computational Design and Engineering*, 6(3), 404-413. <https://doi.org/10.1016/j.jcde.2018.10.001>

### General rights

Copyright and moral rights for the publications made accessible in the public portal are retained by the authors and/or other copyright owners and it is a condition of accessing publications that users recognise and abide by the legal requirements associated with these rights.

For more information, or if you believe that this document breaches copyright, please contact the Bond University research repository coordinator.



# Robotic variable fabric formwork<sup>☆</sup>

Xuyou Yang<sup>a</sup>, Paul Loh<sup>a,\*</sup>, David Leggett<sup>b</sup>

<sup>a</sup>University of Melbourne, Melbourne, Australia

<sup>b</sup>Architectural Research Lab, Melbourne, Australia

## ARTICLE INFO

### Article history:

Received 3 April 2018

Received in revised form 16 September 2018

Accepted 12 October 2018

Available online 12 October 2018

### Keywords:

Digital fabrication  
Robotic production  
Fabric casting

## ABSTRACT

Casting is one of the most widely used construction techniques. Complex geometries produced via computational design processes are not readily achievable through traditional rigid formwork and are subject to increased material waste. More suitable casting techniques are required to represent digital design output efficiently. This article presents a variable fabric formwork developed to work in conjunction with a 6-axis robotic arm for casting doubly curved panels based on hyperbolic paraboloid geometry. The variable formwork is designed to be extendable in length and width so that it can produce a wide range of outcomes within a single formwork. The interface established in the workflow allows the physical formwork and digital design to influence each other. The article concludes by discussing a verification method used to confirm the accuracy of the outcome. This variable fabric form-work reduces construction waste and is a more sustainable method for casting complex geometries.

© 2018 Society for Computational Design and Engineering. Publishing Services by Elsevier. This is an open access article under the CC BY-NC-ND license (<http://creativecommons.org/licenses/by-nc-nd/4.0/>).

## 1. Introduction

Casting is one of the most widely used construction techniques (Lloret, Gramazio, Kohler, & Langenberg, 2013) in architecture. With the emergence of complex geometry in computational designs, traditional casting methods using rigid formwork are limited in responding to the demand for customisable geometry. Recent research in casting using digital fabrication mainly utilises CNC milling as either sacrificial formwork (Lavery, 2013) or in-situ mould (Sousa, Martins, & Varela, 2016). A number of flexible mould designs for precast concrete have been explored using robotic slip forming techniques (Lloret et al., 2013) and multi-point systems (Adapa, 2016). Traditional rigid formwork can be replaced with flexible fabric; such methods have been investigated by various researchers (Kallegias & Erdine, 2015; Pedreschi & Chandler, 2007; Thomas, 2012) as well as in commercial applications (Fab-Form, 2016). The appeal of this system is in its fluid

aesthetic quality and the potential to re-use formwork, thereby reducing waste in mould design. However, there is limited research on the exploration of fabric casting with robotic arms to produce variable geometric panels using a single mould design.

This article discusses the design and fabrication of a variable fabric formwork incorporating the use of a 6-axis robotic arm. The project, titled HYPAR, is the result of a design research studio at the University of Melbourne led by the second and third authors. The studio encourages a bottom-up material approach to design, and in it, the team investigated fabrication techniques for the design of a pavilion structure. They explored a variable casting mould system and the potential for a non-planar quadrilateral panelised system based on the geometric principle of the hyperbolic paraboloid using flexible fabric formwork. The outcome was a series of cast panels (Fig. 1) using moulding plaster, of which Cast 8 (Fig. 11) had the best craftsmanship and is used to evaluate the fabrication accuracy in Section 4.1. Plaster was used instead of concrete for ease of casting and to reduce weight in the fabrication process. This naturally made the panels more fragile and less robust compared to a concrete cast.

This article focuses on the fabrication workflow, material effects and geometric outcome of the test panels. We will discuss the background of the research as well as recent advancements in the field. This is followed by the design of the variable mould system, the robotic fabrication workflow, and how we established the “capability boundary” of the system by which the robotic arm interacts with the mould design to inform the overall design workflow. We conclude the article by evaluating the results from the

<sup>☆</sup> P. Janssen, P. Loh, A. Raonic, M. A. Schnabel (eds.), *Protocols, Flows, and Glitches - Proceedings of the 22nd CAADRIA Conference*, Xi'an Jiaotong-Liverpool University, Suzhou, China, 5–8 April 2017, The Association for Computer-Aided Architectural Design Research in Asia (CAADRIA), Hong Kong. Peer review under responsibility of Society for Computational Design and Engineering.

\* Corresponding author at: University of Melbourne, Faculty of Architecture, Building and Planning, Bldg 133 Masson Road, Melbourne School of Design, Victoria 3010 Australia.

E-mail addresses: [xuyouy@student.unimelb.edu.au](mailto:xuyouy@student.unimelb.edu.au) (X. Yang), [paul.loh@unimelb.edu.au](mailto:paul.loh@unimelb.edu.au) (P. Loh), [david@lds.com.au](mailto:david@lds.com.au) (D. Leggett).

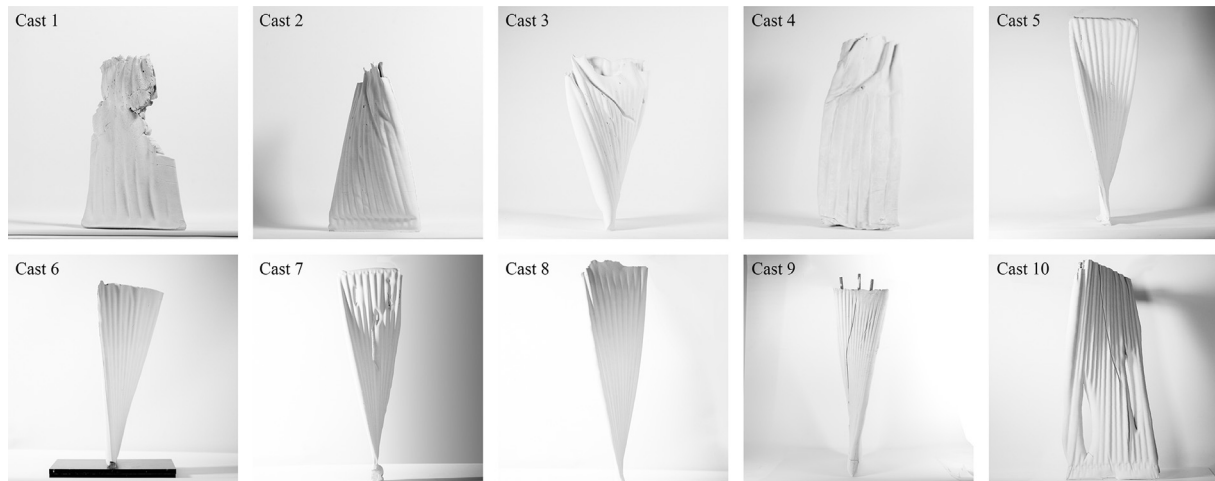

Fig. 1. Cast panels resulting from the experiment.

casting process and test the system against a design proposition to understand its implications.

## 2. Background

Numerous practitioners have explored flexible and transformable formwork in casting. Pneumatically supported tubular formwork systems were used as early as 1938 to construct water pipelines (Sobek, 1986). In the 1960s, Bini established a method of casting concrete shells with inflated membranes (Roessler & Bini, 1986). Unlike conventional rigid formworks, soft formworks have the capacity to cast more complex geometries, namely doubly curved surfaces. The results are typically thinner shells which are structurally more efficient.

Most flexible and transformable formwork utilises fabric as the critical material. Significant developments in fabric formwork were made in the late 18th and the 19th century as a result of the Industrial Revolution (Veenendaal, West, & Block, 2011). While traditionally seen as a utilitarian application for its simplicity and cost-effectiveness, it was not until the 1950s that fabric formwork was used and explored in architectural projects by Miguel Fisac and later Mark West (CAST, 2016) and Kenzo Unno. Veenendaal et al. (2011) outlined the limitation of research in this field and identified the key challenges. For example, the double curvature geometry is implicit to the fabric formwork, and this tends to limit its application in traditional design.

### 2.1. Use of robotics in casting techniques

Recent research projects in casting have explored the use of industrial robotic arms to manipulate variable formworks to explore novel techniques and material expressions. While the research in this field is limited, two key projects are relevant to our discussion. First is the Robotic Slipforming project conducted at ETH Zurich, which used a robotic arm to manipulate a cylindrical formwork, which was rotated and extended in height to form “double curved” columns (Lloret et al., 2013). The second is Fabric Form, developed at UCLA, which employed two robotic arms to stretch a truncated fabric formwork to a scripted geometry, resulting in concrete components that could be accumulated to form a lattice frame (Culver, Koerner, & Sarafian, 2016). Both projects utilised the robotic arm as the primary device to produce a trajectory for the form-work to move it from its start to the rest position. Here, the choreography of the production process conditioned by the anatomy of the robotic arm delivered a set of dynamic rules which could

become a driver for design (Ameijde & Carlin, 2012). As Gramazio and Kohler (2018) point out, “We design a behaviour”.

The main differences between HYPAR and projects mentioned above are:

1. HYPAR is designed to produce a non-planar quadrilateral surface. The doubly curved nature of the fabric formwork highlighted above is useful in the design and development of this surface.
2. Unlike Fabric Form (Culver et al., 2016), the fabric formwork utilised the “ruling” of the hyperbolic paraboloid surface as a principal to extend the length of the panel. In practice, the panel can vary in width and length.
3. If the length remains constant or within the stretch limits of the fabric, the same fabric formwork can be reused to produce variable geometries.

### 2.2. Ruled surface geometry

The geometry produced by HYPAR is based on the hyperbolic paraboloid, a doubly curved, saddle-like ruled surface. In architectural design, this geometry has been widely used, most notably in Antoni Gaudi’s geometric development of the Sagrada Família (Burry, 2011). Similar geometry is also deployed in the roof structure of St Mary’s Cathedral in San Francisco by Pier Luigi Nervi. Here, eight hyperbolic paraboloids are used to generate the spatial transformation from a square on the plan to a cross at the apex of the roof. The assembly of the roof (Fig. 2) is made possible by employing a straight timber plank as scaffolding to support the triangulated pre-cast concrete panels (Nervi, 1965); this demonstrates the advantage of deploying ruled surfaces in the construction of a complex doubly curved roof.

There are three critical characteristics of the hyperbolic paraboloid that are critical to this project. Firstly, for any ruled surface, a single straight line lying on that surface will pass through a given point resting on that surface (Burry, 2011) (Fig. 3A). The straight line is referred to as a ruling. For a hyperbolic paraboloid, every position on the surface has two lines passing through it, making it a doubly ruled surface. This geometric property makes the hyperbolic paraboloid load-resistant in two directions (Farshad, 1992), but more importantly, the ruling, as a straight line or edge, can be articulated as a physical material, which is useful for the fabrication of a mould.

Second, not all ruled surface geometries are developable. Hyperbolic paraboloids as explored in HYPAR are quadric surfaces, which are non-developable, as the ruling consists of the

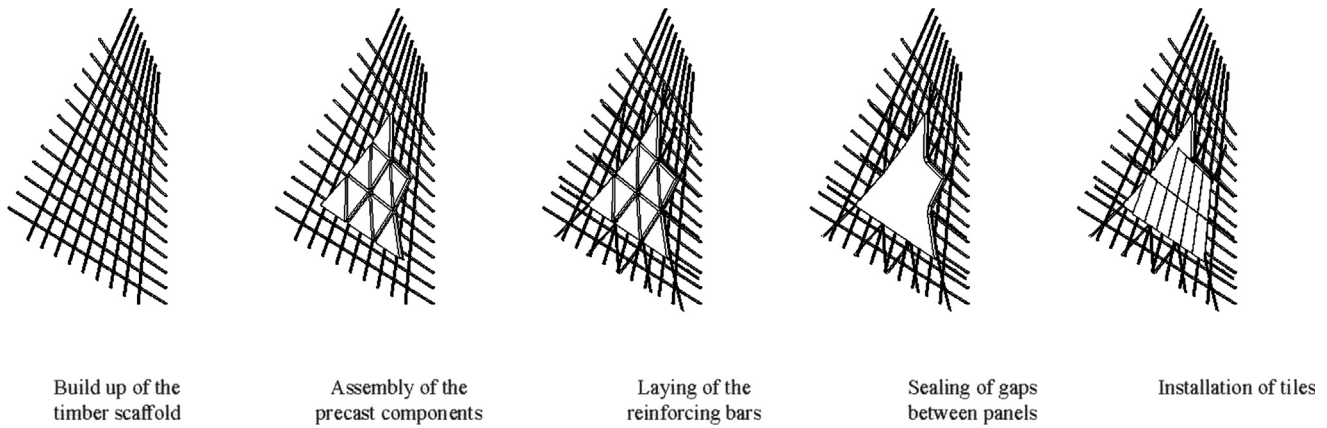

Fig. 2. Study of the construction process of the roof of St Mary's Cathedral.

non-torsal generator where the tangent plane at any point on the surface is different from other locations on the surface (Pottman, 2007). Despite the non-developable nature of the surface, it is possible to define this “warped ruled surface” geometry by the four corners of the quadric surface. In HYPAR, we reduced the four corners into two opposite edges as the primary parameter (Fig. 3B).

Third, the nature of the geometry allows the possibility of joining hyperbolic paraboloid panels at their edges. A characteristic of this second order geometry, as Burry (Burry, 2011) pointed out, is that it can be fragmented into individual components which, when combined, can still form a seamless surface (Fig. 3C). Complexity arises when the surface assumes a thickness, as in casting a panel. The four edge faces of the panel would also be ruled warped surfaces. These three characteristics of hyperbolic paraboloids acted as the primary parameters in the design and development of HYPAR.

### 3. Design and fabrication of variable mould

HYPAR is designed as a variable fabric mould controlled using a 6-axis robotic arm. Fig. 3 illustrates the configuration of the latest iteration of the mould. This mould is used to cast a 300 mm wide  $\times$  900 mm length  $\times$  50 mm thick panel.

The mould consists of the following parts, each corresponding to the index illustrated in Fig. 4.

- (1) Bespoke end effector. The end effector attached to the robotic arm is a modified pneumatic gripper with a pair of 3D printed ABS plastic teeth. The pair of negative teeth were fixed onto the top clamp (2).
- (2) Top clamp. A CNC-milled MDF panel with a pair of bespoke clamps where the fabric formwork and aluminium tubes are fixed to a horizontal plate. The width of the panel is pre-set, but the mould can be adapted to increase or decrease its width.

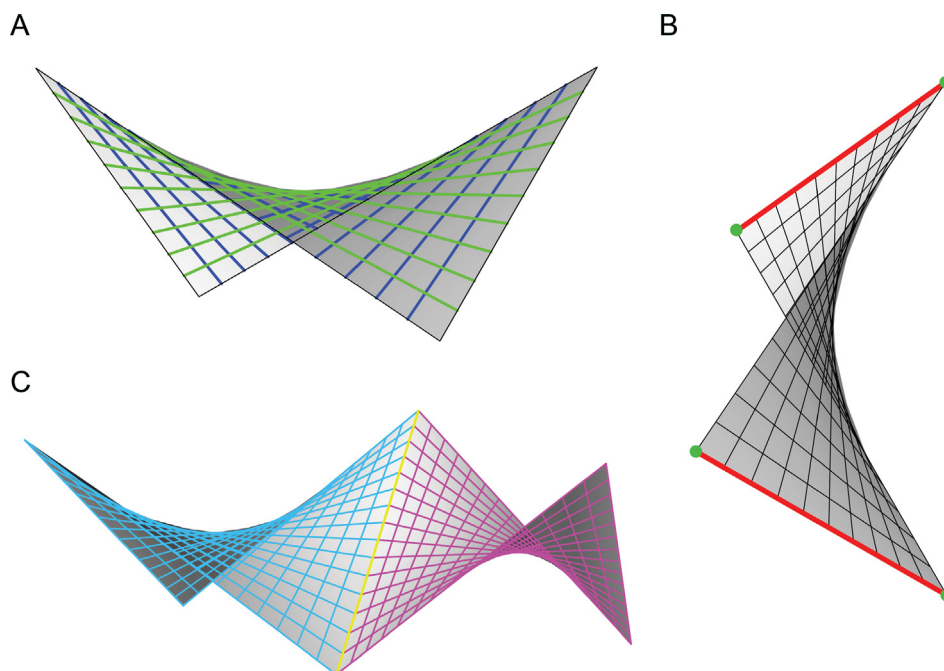

Fig. 3. Key characteristics of the hyperbolic paraboloid.

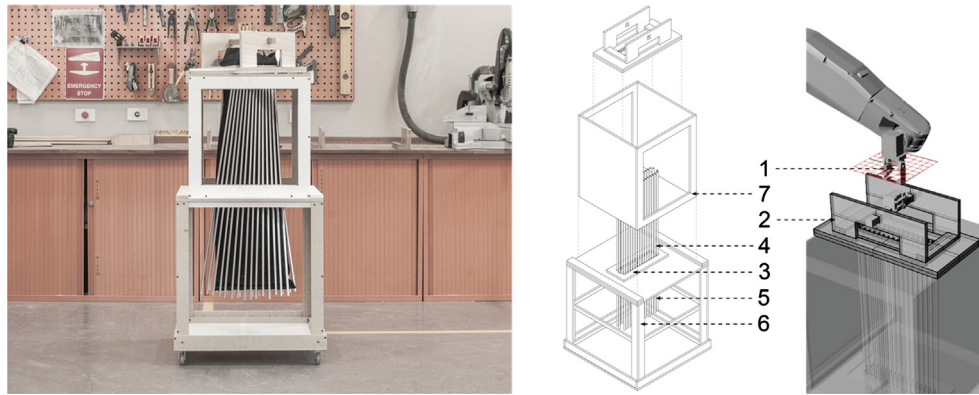

Fig. 4. Variable mould and diagram showing parts.

- (3) Bottom clamp. A CNC-milled MDF panel with a slot acting as a guide for the ruling aluminium tubes. The bottom width of the panel has potential to vary, like the top clamp.
- (4) Ruling. 30 pieces of 1-meter-long hollow aluminium tubes with 20 mm centres. The tubes are pin jointed at the top clamp (2) but are not constrained at the bottom, which allows a certain amount of movement and rotation and for variation in the length ( $L$ ) of the panel. In this case the length constraint is  $388 \text{ mm} < L < 900 \text{ mm}$ . The ruling of the hyperbolic paraboloid surface is used to provide a framework to the otherwise flexible fabric formwork; the rigid rulings act as a control parameter for the panel's thickness.
- (5) Fabric formwork. The fabric used is a mixture of 95% polyester and 5% Lycra, stitched with a sewing machine into a rectangular pocket. It is placed in between the rulings and is only clamped from the top with an opening to allow the pouring of plaster.
- (6) Carcass. The carcass is a CNC-milled MDF and softwood timber frame supporting the bottom clamp. Its purpose is to provide a rest position for the mould. It does not support the weight of the cast, which is primarily held up by the robotic arm.
- (7) Temporary frame. The frame is removed after the robotic arm engages with the mould via the end effector (1).

For individual casts, the bottom edge of the fabric formwork (5) is fixed at the same place at the bottom clamp (3), but the height, rotation and tilting of the top clamp (2) can vary for each cast, thus generating variable formwork.

In the development of this variable fabric formwork, five iterations of the mould were constructed, tested and improved. The first mould was designed as a manual input device to attain the fundamental principle of a hyperbolic paraboloid cast with the aid of flexible cables along the fabric to retain the ruling of the surface. Once a successful cast was made manually, the robotic interface was developed to pair the formwork with the 6-axis robotic arm. The study employed an ABB IRB 1200-5/0.9 with a 901 mm reach and 5 kg payload. Fig. 5 illustrates three of the five mould designs and the progression from manual control to automation using the robotic arm.

A significant improvement to the system was made when the elastic ruling was abandoned in favour of a rigid tube system constrained in one direction. The use of a rigid ruling system outside of the fabric effectively minimised uncontrollable bulging of the fabric under the hydrostatic pressure of the plaster.

Further improvements in the final iteration of the mould were made to increase the height and thickness of the cast. With this came the need for a stronger ruling component along the side of the fabric to support the cast (refer to Fig. 4). The design team also



Fig. 5. Various iterations of mould design. Iterations 4 (left) and 5 (middle) are manually operated. The latest design (right) is paired with the robotic arm.

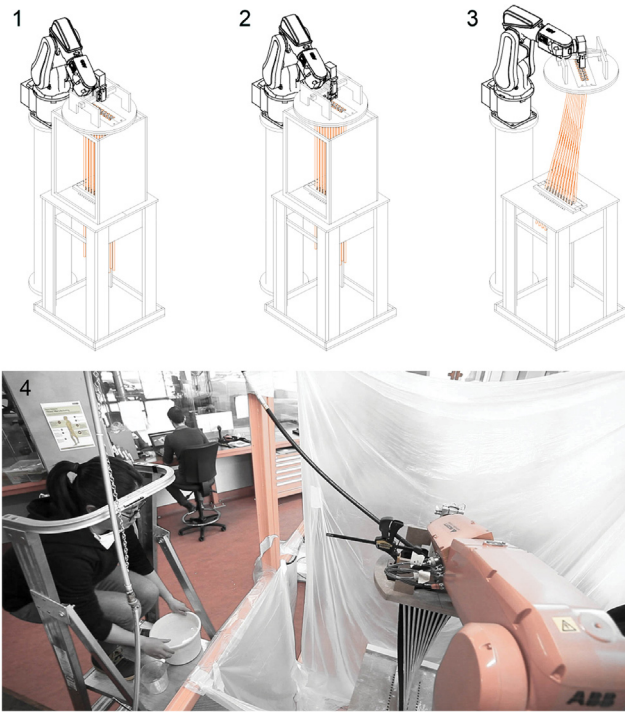

Fig. 6. Fabrication workflow of HYPAR. (1) The robotic arm engages the mould. (2) The mould is lifted and the temporary frame removed. (3) The mould is stretched to the target position. (4) Plaster is poured from the top.

integrated pipes in the final cast and developed design opportunities for apertures; these are discussed in Section 4.2.

3.1. Fabrication workflow

The fabrication procedure was simulated in a virtual environment before using the robotic arm to engage with the mould. Fig. 6 demonstrates the fabrication process of the panels. Ten separate casts, as illustrated in Fig. 1, were made to acquire and develop the skill of casting, each progressively larger in size, from 300 mm to 900 mm tall. This iterative procedure allows the system to be refined, for example, regarding how to control leaks and improve the quality of the mould.

As discussed in Section 2.2, this second-order geometry has a unique characteristic that enables a doubly curved surface, for example, a shell structure, to be panelised and combined to form a free-form surface. The design team tested the hyperbolic paraboloid geometry on a shell structure as a design response to the stu-

dio brief (refer to Fig. 14A). The geometry of various hyperbolic paraboloid panels as the outcome of the design were taken as the input to the digital workflow. A visual script was written in Grasshopper 0.9.0076 to generate a robot target frame for any hyperbolic paraboloid panel. Fig. 7 outlines the robotic workflow associated with the mould design. The panel is oriented to align with the bottom clamp of the mould in Rhino 3D (Fig. 7A). A plane is defined at the centre of each panel's top edge and is offset to the top clamp position (refer to Fig. 4(2)). This is referenced as one of the target frames for the robotic arm when the fabric mould is formed into the resulting hyperbolic paraboloid geometry. Other necessary target frames, indicating the starting position of the robotic arm, its gripper closing position, and the temporary frame position that removes the temporary support of the top clamp, are part of the movement information translated into the trajectory of the robotic arm for each corresponding form (Fig. 7B).

3.2. Establishing the capability boundary of the system

The various material systems, such as the ruling and the fabric, as well as the parameters of the hyperbolic paraboloid geometry, intrinsically constrain the mould design. The investigation identified the limitations of the system. For example, the mould design is hindered by the pin joint of the ruling tube, which limits the rotation of the robotic arm. Additionally, the robotic arm, however flexible and accurate, had a weight limit, which was reached upon casting a 900 mm tall cast; efforts to cast larger and wider panels would require robotic arms with larger payloads and corresponding ruling members that would not buckle under hydrostatic pressure and the weight of the cast. In this project, the limitations caused by the stretch and panelisation of the fabric in the formwork were tested and used to establish an interaction between the mould and the robotic arm. This in turns informs the architectural design by aligning the design constraints with the fabrication capacity.

The interface between the mould and the arm was a critical aspect of the fabrication process. While digital stimulation of the robotic arm was undertaken in Grasshopper with the Taco ABB plugin and RobotStudio 6.03.01, this only allowed the team to understand the trajectory of the robotic arm without taking into consideration the material constraints of the formwork system. Other factors were missing from this stimulation; for instance, what was the reach limit in relationship to the ruling tubes? What was the maximum angle of rotation before the rulings start to collide?

To understand the capabilities and constraints of the fabric formwork system with the robotic arm, the two components were connected to each other to explore the limitations of the system through a physical simulation without any cast. The

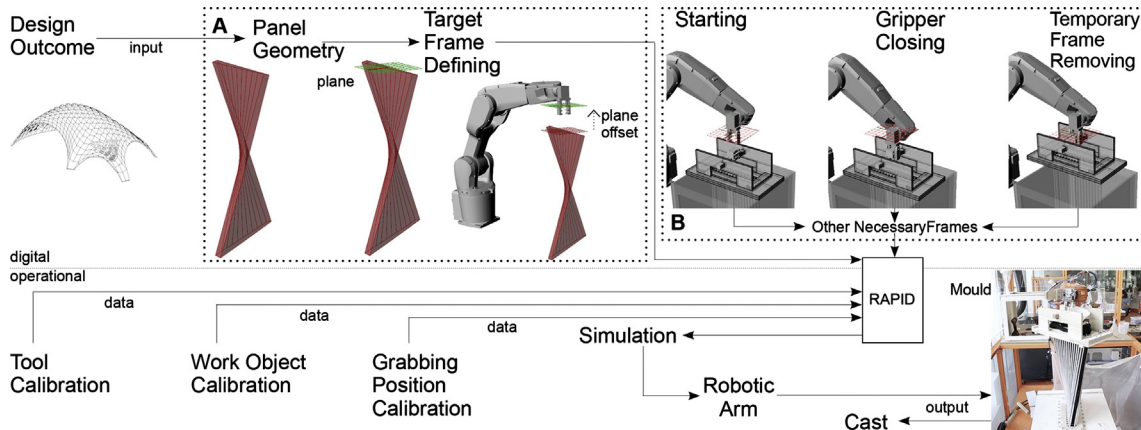

Fig. 7. Robotic workflow of HYPAR.

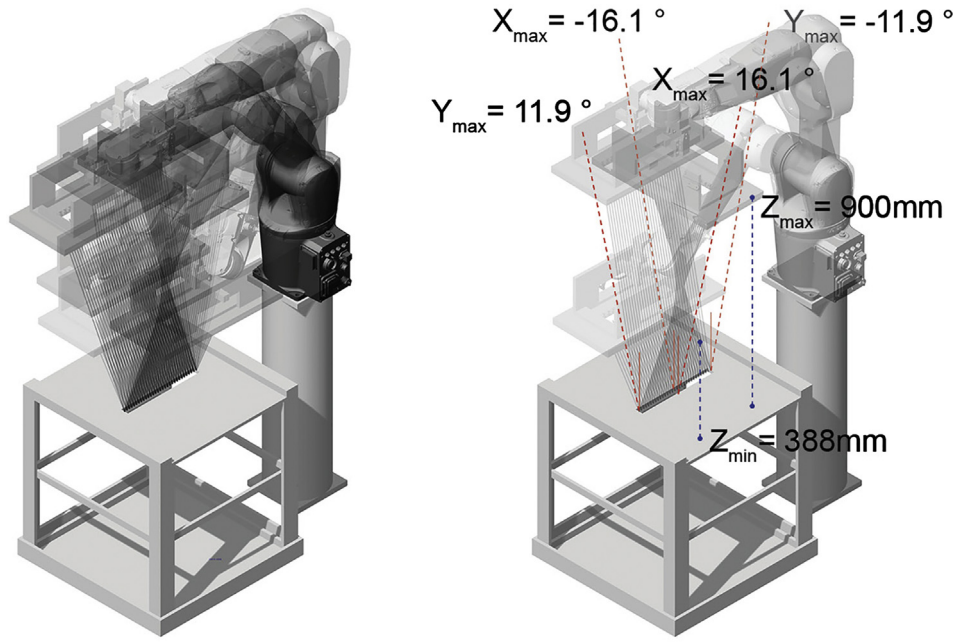

Fig. 8. Left, robotic arm and mould interaction. Right, capability boundary of the system.

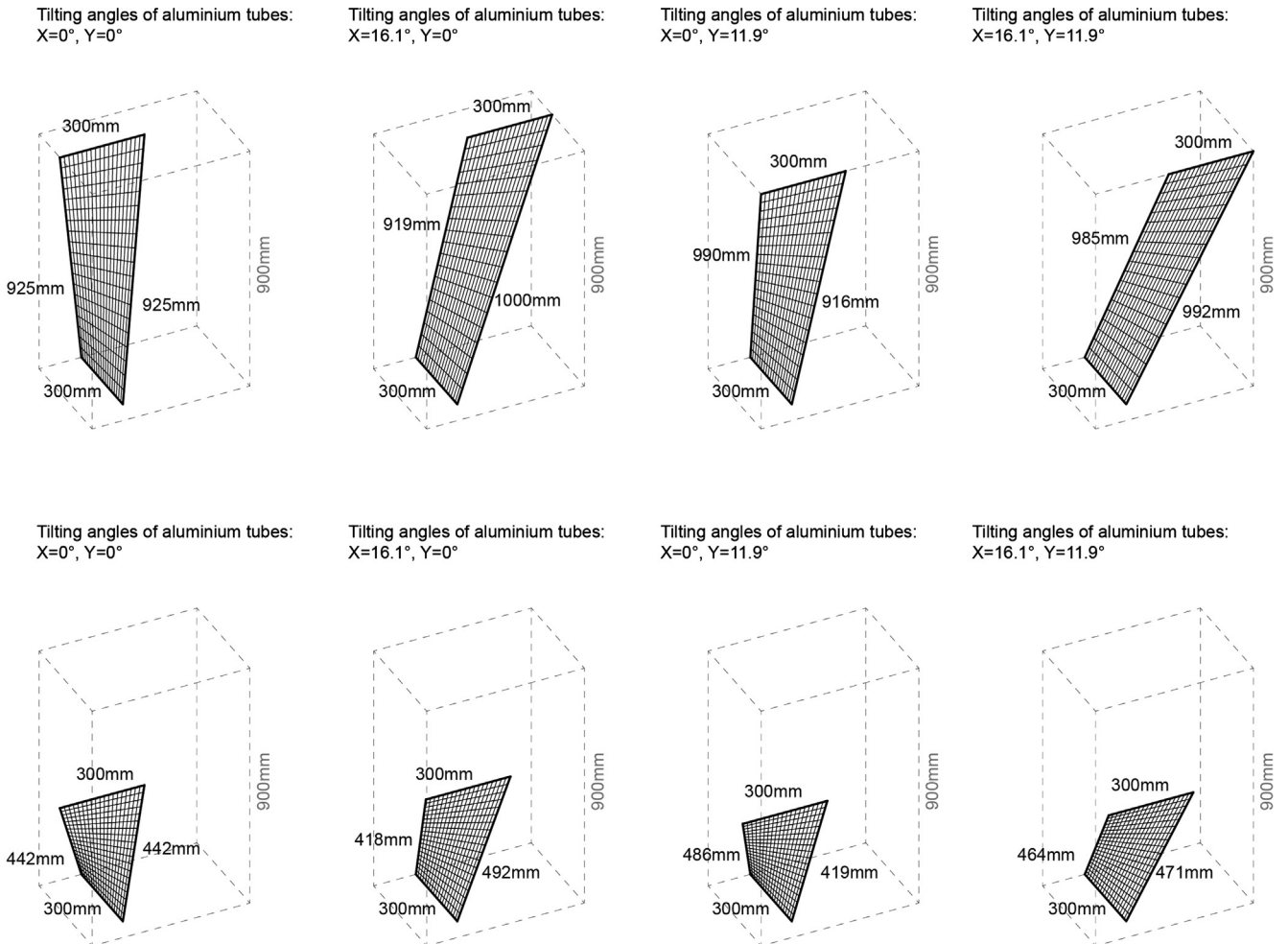

Fig. 9. The geometric range provided by the capability boundary of the system.

mould was placed within the range of the robotic arm and manually jogged to its maximum reach along X, Y, and Z axes until the joints hindered the tilting angles of the aluminium tubes at the bottom clamp, or the aluminium tubes had run out of its reach. The range is 23.8 degrees in the X-axis and 32.2 degrees in the Y axis. A “capability boundary” can be established in this simulation process, as illustrated in Fig. 8, and a geometric range can be generated from this capability boundary, as demonstrated in Fig. 9.

Here, the interaction between the mould and the robotic arm was used to understand the limits of the system. It was useful to complete the design workflow with an information loop established between the design and the workflow associated with the system (Fig. 10). The data collected from the reach limit of the ruling was used to understand the movement of the robotic arm within the capability boundary. This was incorporated into the robot coding process (Fig. 10D) and used to inform the computational design of the architectural project as part of the parameter modelling, for example, to optimise the size and shape of the panel subdivisions in the form-generating process (Fig. 10E). This ensured that all panel sizes were within the possible geometric range and thus could be fabricated within the fabric formwork system.

**4. Evaluation and future inquiry**

In this section, we evaluate the physical outcome of the experiment through a verification process in which we match the virtual surface with the physical object. Here, we identify improvements to the system and test the findings against a design proposition.

**4.1. Fabrication accuracy**

During the casting process, the fabric formwork is stretched by a combination of forces (Veenendaal & Block, 2012). First, it is pre-stressed when the robotic arm moves the top clamp (as shown in



Fig. 11. Cast 8, used in the verification process.

Fig. 4(2)) from its initial position to the target frame. Second, the fabric stretches again when the plaster fluid is poured into the mould, which adds to the in-plane stress and plane-to-normal pressure of the fabric pocket. Although a total of fifteen aluminium

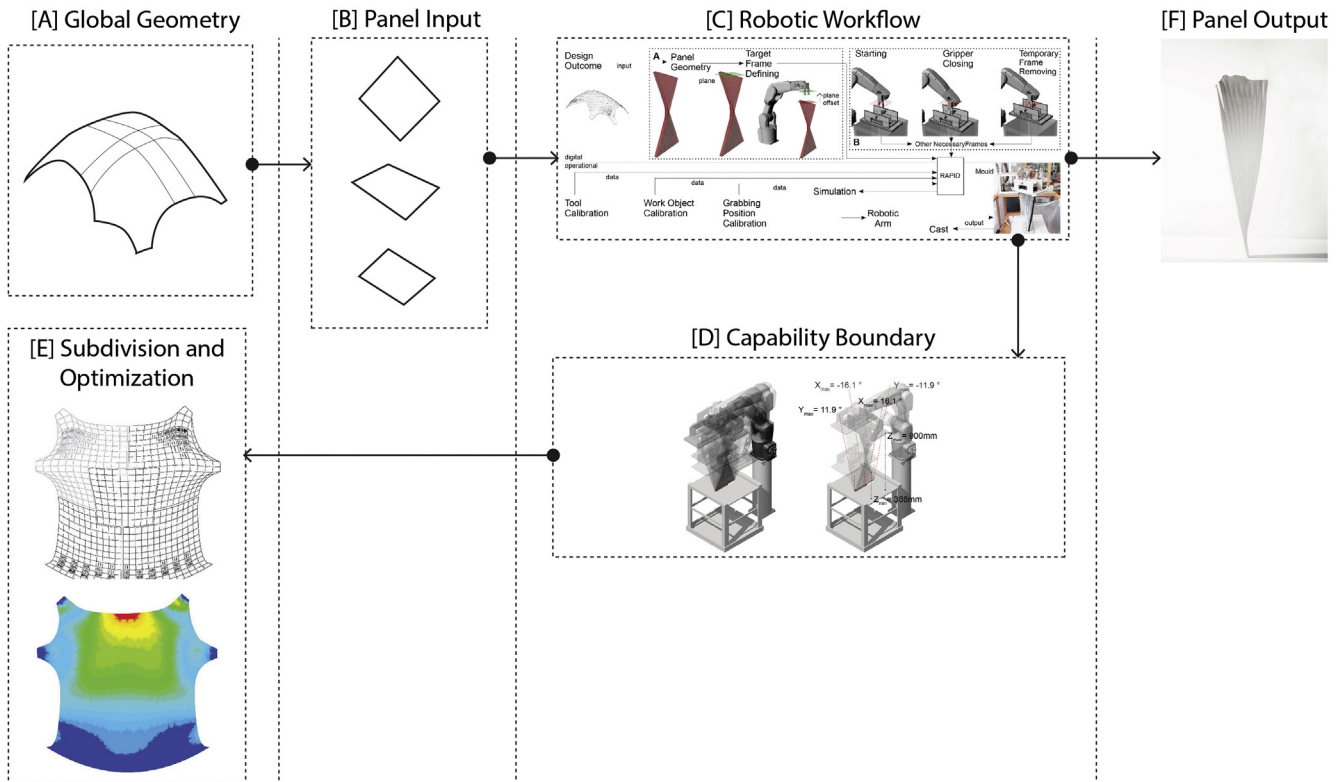

Fig. 10. Design workflow in relation to robotic workflows.



rulings were used on each side of the fabric formwork to contain the cast in the fabric pocket, it remains difficult to control the stretch of the fabric fully, as the plaster fluid bulges between the aluminium tubes during the fabrication process.

A script was developed in Grasshopper with the Kangaroo plugin to simulate the resulting forms. Hyperbolic paraboloid surfaces generated with the top and bottom edges were used as the initial geometry in the script. A pressure force was used to simulate the bulging effect between the rulings, where the fabric pocket is constrained.

To understand the accuracy of the system, we verified the digital stimulated surface against the cast panel. Cast number 8 was taken as a sample for its appropriate scale and craftsmanship (Fig. 11). The plaster cast was scanned with an Eva 3D Scanner with an accuracy of 0.1 mm and a global registration error of 0 – 0.3 mm. The scanned mesh was aligned with the digital model, and two sets of points were used to confirm the accuracy of the panel, as illustrated in Fig. 12. The first was a cross-section domain of the panel, which measured the cross-section differences between the digital surface and the scanned surface. The second set applied a grid to map the surface domain; a network of points

was defined on the digital surface and projected onto the scanned geometry in the surfaces' normal directions. The distances from the points on the digital model to the projected points on the scanned geometry were used to measure the discrepancy between the digital simulation and the actual cast.

As Fig. 12 illustrates, the cross-section deviation of Cast 8 ranges from 4.2 mm to 14.1 mm, whereas the surface deviation is between 0 mm and 13.6 mm. This result suggests that the panels fabricated with the mould can achieve a certain degree of accuracy, but it does not satisfy industrial standards. For example, if the panel is to be used for panel construction in concrete, the deviation will need to be within  $\pm 3$  mm according to Australian Standard AS3850-2003. The results also suggest that the surface deviation increases towards the middle part of the cast and away from the top and bottom clamps, where the fabric pocket was least restrained.

The study suggests that the following adjustments could be made to the mould design to improve the accuracy of the system.

- The joints of the rulings to the base frame need to be universal and allow for non-constrained rotation.

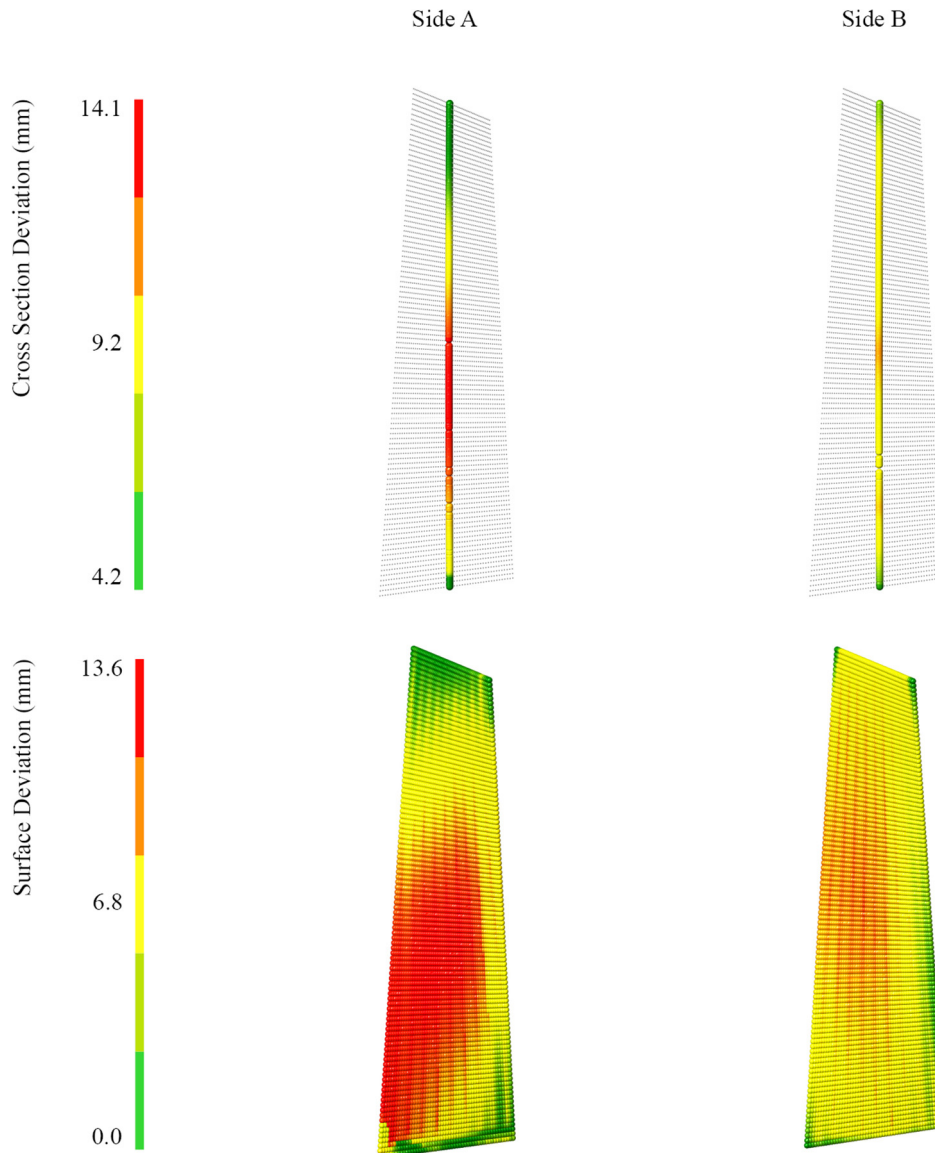

Fig. 12. Distribution of cross-section and surface deviation.

- The spacing of the rulings determines the size of the bulges between them. This could explain the 10 mm deviation of the surface and, in particular, the vertical distribution, as indicated in Fig. 12. In future research, the spacing between the rulings will need to be reduced. Naturally, this is constrained by the universal joint at the clamp.
- The distribution of deviation suggests that more constraints will need to be added to the middle segment of the fabric formwork during the casting process to reduce the uncontrolled stretch and buckling of the rulings under hydrostatic pressure.

#### 4.2. Design implication and potential

As discussed in Section 3.2, the team tested the geometrical possibilities of HYPAR in a shell structure design. The limits of the system were identified through the interaction of the robotic arm and the mould. This provided the parameters for the architectural proposal (Fig. 14). Considering the material study, two potentials of the design are worth noting. The first is the ability of the hyperbolic paraboloid surface to act as an acoustic diffuser, where the twist of the individual surface can be parametrically adjusted.

The second potential emerges from the fabrication process. While the aluminium rulings minimised the bulging of the fabric under the hydrostatic pressure of the plaster, the fabric continued to bulge between the aluminium tubes. This was found to be an

interesting visual effect that could be taken forward in the architectural proposal. It allowed the design team to consider embedding pipes within the cast for evaporative cooling purposes (refer to Fig. 13).

Pipe-embedded building envelopes have been developed recently to reduce heat transfer through facades that have the capacity to utilise passive cooling instead of mechanical cooling (Shen & Li, 2016). Other researchers have been exploring the potential of porous ceramic pipes to absorb water and act as passive cooling devices; the potential of this inquiry is in its capacity to combat the urban heat island effect (Chen, Liu, & Lin, 2015).

HYPAR points to further possibilities of these evaporative cooling techniques by embedding water pipes that could release water from within the cast, allowing it to saturate the outer surface and create a cooling effect in conjunction with air movement. Initial analysis of the cast panel suggests that the aperture in the panel has the capacity to develop a disturbance increasing air to surface contact, thereby assisting evaporative cooling (refer to Fig. 14).

A challenge of the system was confronted when the panels assumed a thickness and individual panels needed to be butt jointed together edge-to-edge. In the latest mould design, the side is cast using the aluminium tube ruling. As the panel has a 50 mm thickness, the ruling aluminium tube did not produce an accurate profile or sufficiently tight tolerance for the panel to be butt together (refer to the desired profile outline illustrated in Fig. 13). This will continue to be investigated in future research.



Fig. 13. Aluminium pipes embedded in the hyperbolic paraboloid panel.

#### 5. Conclusion

HYPAR suggests a novel fabrication technique that integrates a robotic arm within its fabrication protocol to produce hyperbolic paraboloid cast panels. While the current design has limitations, the research identifies a future area of investigation for fabric casting using robotic arms. The design procedure for the mould highlighted the need for interaction between the robotic arm and the mould to set up a continuous feedback mechanism and improve the various iterations of the mould. It also set up a digital workflow that has implications for the form-generating process, integrating the logic and characteristics of hyperbolic paraboloid geometry,

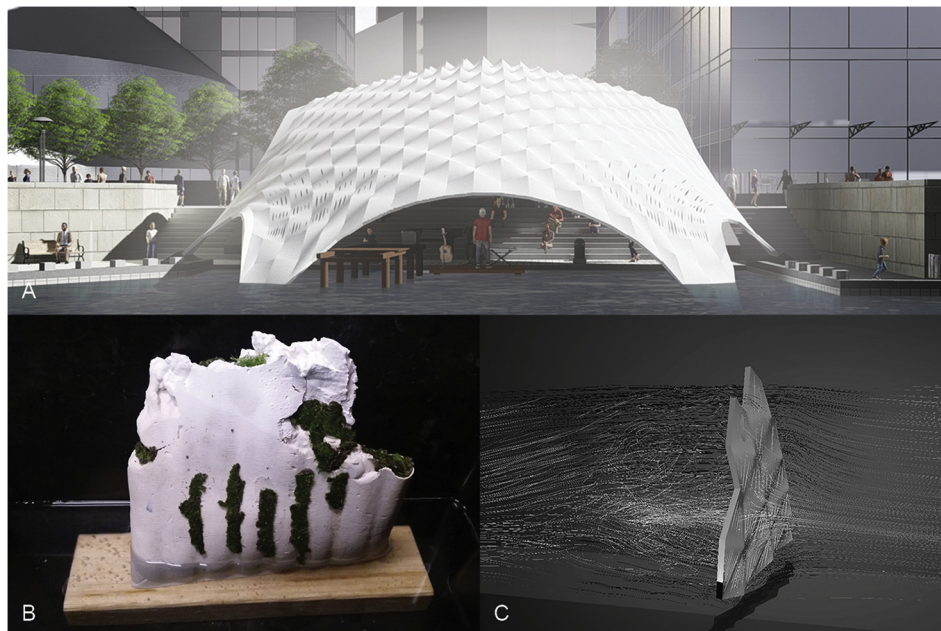

Fig. 14. A: The architectural proposal. B: Moss growth demonstrating absorption of water by the cast. C: Wind study of apertures.

translating this into material articulation and behaviour of the robotic arm, and resulting in the transformation of the geometry. This fabrication method promises to reduce material waste and manual labour in the construction of complex doubly curved panels. The mould design is a step towards a more sustainable means of construction in the wake of the application of parametric and computational design to construction. The responsibility, however, still lies with us as designers and architects to construct new ways of reducing the impact on our built environment, not just through design performance but also through the integration of advanced fabrication processes.

### Conflict of interest

The authors declare that there is no conflict of interest.

### Acknowledgement

The authors acknowledge the contribution of Shawn Koh Jyh Shen as a team member of this research and input to the previous publication of this project. We recognise the technical contribution of Joshua Russo-Batterham and staff in the robotics lab at the Melbourne School of Design. We thank ARUP Melbourne for their generous technical advice. The project had benefited from the Architect Michael Kaufman Scholarship.

### References

- Adapa (2016). Adapa – Adaptive moulds. Available from <[www.adapa.dk](http://www.adapa.dk)> Cited 18 Sep. 2016.
- Ameijde, J., & Carlin, B. (2012). Digital construction: Automated design and construction. Experiments using customised on-site digital devices. In *Proceedings of the 30th eCAADe conference* pp. 439–446.
- Burry, M. (2011). *Scripting cultures: Architectural design and programming*. John Wiley & Sons, Inc.
- Burry, M. (2011). Geometry working beyond effect. *Architectural Design*, 81(4), 80–89.
- CAST (2016). Centre for Architectural Structures and Technology. Available from <<http://umanitoba.ca/faculties/architecture/facilities/cast.html>> Cited 18 Sep. 2016.
- Chen, W., Liu, S., & Lin, J. (2015). Analysis on the passive evaporative cooling wall constructed of porous ceramic pipes with water sucking ability. *Energy and Buildings*, 86, 541–549.
- Culver, R., Koerner, J., & Sarafian, J. (2016). Fabric forms: The robotic positioning of fabric formwork, robotic fabrication in architecture, art and design, pp. 107–121.
- Fab-Form (2016). Fab-Form. Available from <<http://www.fab-form.com>> Cited 1st November 2016.
- Farshad, M. (1992). *Design and analysis of shell structures*. Netherlands: Springer.
- Gramazio, F., & Kohler, M. (2018). *Digital materiality in architecture*. Lars Müller Publishers.
- Kallegias, A., & Erdine, E. (2015). Design by nature: Concrete infiltrations. In *Proceedings of the 33rd eCAADe conference* pp. 513–520.
- Lavery, C. (2013). Spencer dock bridge. *Concrete International*, June, pp. 28–31.
- Lloret, K. E., Gramazio, F., Kohler, M., & Langenberg, S. (2013). Complex concrete constructions. *Proceedings of 18th international conference of CAADRIA* pp. 613–622.
- Nervi, P. L. (1965). *Aesthetics and technology in building*. Harvard University Press.
- Pedreschi, R., & Chandler, A. (2007). *Fabric formwork*. RIBA Publishing.
- Pottman, H. (2007). *Architectural geometry*. Bentley Institute Press.
- Roessler, S. R., & Bini, D. (1986). The Binishell system – Thin shell concrete domes. *Concrete International*, 8, 49–53.
- Shen, C., & Li, X. (2016). Dynamic thermal performance of pipe-embedded building envelope utilizing evaporative cooling water in the cooling season. *Applied Thermal Engineering*, 106, 1103–1113.
- Sobek, W. (1986). Concrete shells constructed on pneumatic formwork, Shells, membranes and space frames pp. 337–344.
- Sousa, J. P., Martins, P., & Varela, P. D. A. (2016). The CorkCrete arch project, living systems and micro-utopias: Towards continuous designing. In *Proceedings of the 21st international conference of CAADRIA* pp. 735–744.
- Thomas, K. L. (2012). Casting operations and the description of process. *The Journal of Architecture*, 20(3), 430–444.
- Veenendaal, D., & Block, P. (2012). Computational form-finding of fabric formworks: An overview and discussion. In *Proceedings of the 2nd international conference on flexible formworks (icff2012)* pp. 368–378.
- Veenendaal, D., West, M., & Block, P. (2011). History and overview of fabric formwork: Using fabrics for concrete casting. *Structural Concrete*, 12(3), 164–177.